







Model Code: 13 CAN400EG

Included Accessories

 UMG8	 Waste Kit	 Waste Cover
 Drainer Grid	 Sink Care Pack	

Optional Accessories

 13 DTN18EG	 14 CBF260R10N	 14 CBF340R10N

Dimensions

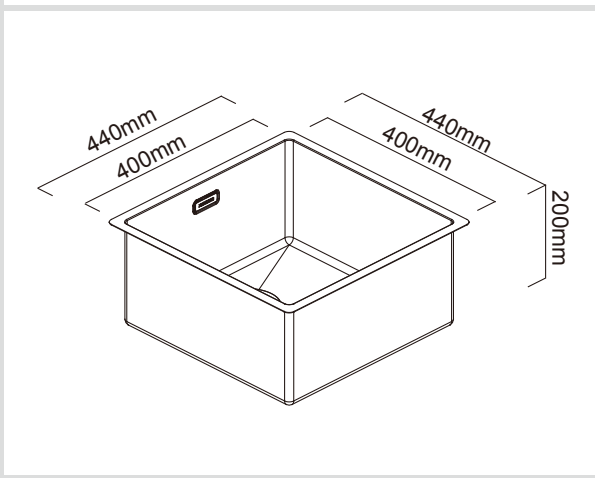

Specifications

Description	Single Bowl, Undermount Sink
Overall Sink Size	440mm x 440mm x 200mm deep
Bowl Dimensions	400mm x 400mm x 200mm deep
Drainer Length	N/A
Technic	Fabrication
Material	Stainless steel SUS304

Installation



Fixings	Undermount clips supplied
Template	N/A
Min Cabinet Size	500mm
Waste Holes	1 x 90mm round Compatible with waste disposal



Plumbing

Waste Fittings	1 x (90mm x 1 1/2") basket wastes included
Overflow	Available, conditions apply

Packaging

Carton Type	EPS protection & individual carton
Gross Weight	5.56Kg
Carton Size	520mm x 286mm x 513mm
Pack QTY	1

SURFACE FINISH  Microbrush	WASTE KIT 	MATERIAL  Stainless Steel
--	---	---

INSTALLATION OPTIONS  Undermount	PROFILE  Horiz
--	--

Burns & Ferrall is pleased to offer a limited 25-year warranty on all Zomodo sinks used in normal domestic installations. Burns & Ferrall warrants its sinks to be free from all manufacturing defects in material and workmanship. Burns & Ferrall warrants Zomodo waste kits, basket sieves and overflow assembly to be free from manufacturing defects for a period of one (1) year. Burns & Ferrall warrants Zomodo taps' stainless steel casing to be free from manufacturing defects for a period of twenty-five (25) years, the supply hose and inner cartridge for a period of five (5) years, and the inner parts including the aerator and O-ring for a period of one (1) year from the date of purchase. Burns & Ferrall will repair or replace (at Burns & Ferrall's discretion), at no charge, excluding labour, any product supplied by Burns & Ferrall that is proven to be defective under normal use.

Please visit www.zomodo.co.nz/warranty for full terms & conditions.