

SPECIFICATION SHEET

Skye 1500mm 4 Drawer Wall Vanity with Single Basin



Features

- Wall Hung
- Full Extension Soft Close Drawers
- Cabinet:
White - 2-Pack Urethane on MRF
Colour - Laminate Finish
- Slab Top Options:
20mm Quartz Top or StoneCast Top
- Dimensions: H670 x W1500 x D465

*Note: Vessel basins are purchased separately.
Visit www.newtech.co.nz for full range of vessel basin options.*

Cabinet Options

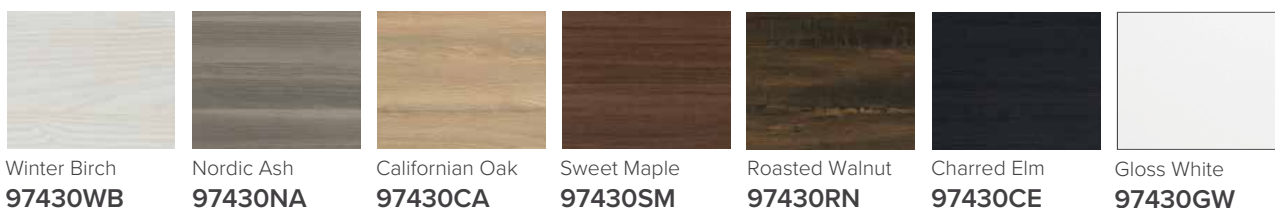

Winter Birch
97430WB

Nordic Ash
97430NA

Californian Oak
97430CA

Sweet Maple
97430SM

Roasted Walnut
97430RN

Charred Elm
97430CE

Gloss White
97430GW

StoneCast Slab Top Options



Gloss White
SC

Matte White
SCMW

Quartz Slab Top Options

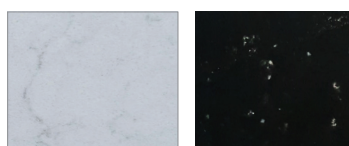

Himalaya
HY

Midnight Stone
MS

Note: To order a Slab Top, add the slab top code to the cabinet code.

Technical Details

Note: All measurements shown are in millimetres. Sizes are nominal.

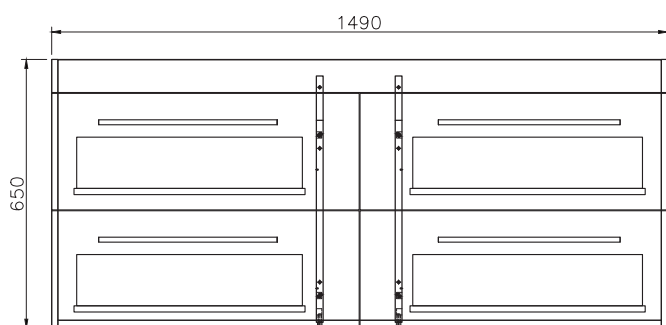

FRONT VIEW

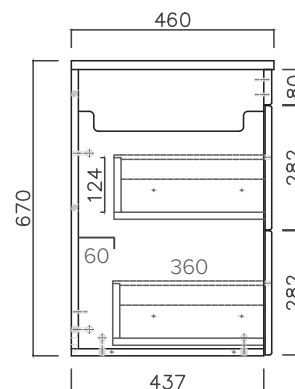

SIDE VIEW

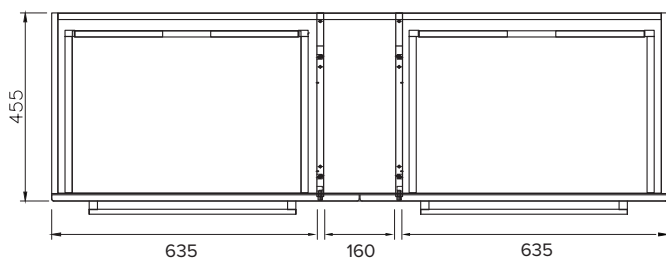

TOP VIEW

SPECIFICATION SHEET

Slab Top Options

StoneCast Slab Top 1500

W1500 x D465 x H20

Gloss White - SC

Matte White - SCMW

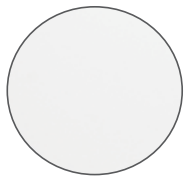
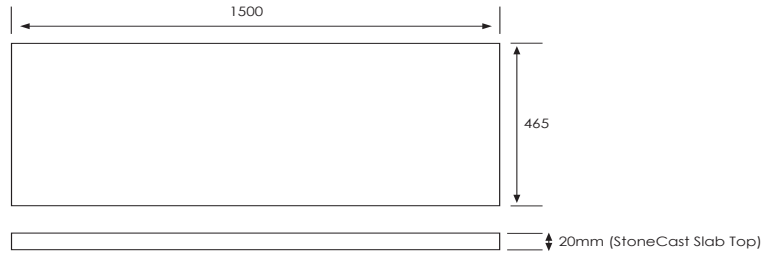
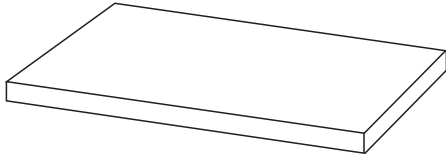

Gloss White



Matte White

Quartz Slab Top 1500

W1500 x D465 x H20

Midnight Stone - MS

Himalaya - HY

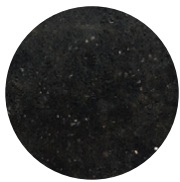
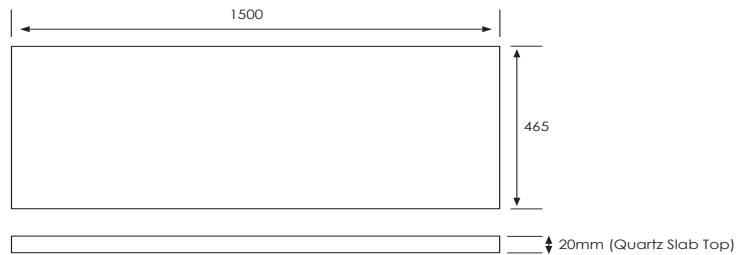
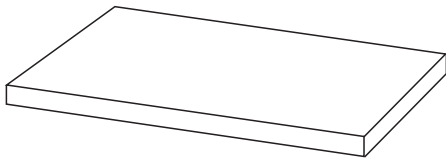

Midnight Stone

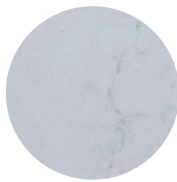

Himalaya

Tap Hole Position

Tap hole position must be specified

- NTH** No Tap Holes
- CTH** Centre Tap Holes
- LTH** Left Tap Holes
- RTH** Right Tap Holes
- ITH*** Inside Tap Holes
- OTH*** Outside Tap Holes

*only applicable with double basins