

SPECIFICATION SHEET

Skye 1500mm 2 Drawer Wall Vanity with Single Basin



Features

- Wall Hung
- Full Extension Soft Close Drawers
- Cabinet:
White - 2-Pack Urethane on MRF
Colour - Laminate Finish
- Slab Top Options:
20mm Quartz Top or StoneCast Top
- Dimensions: H420 x W1500 x D465

*Note: Vessel basins are purchased separately.
Visit www.newtech.co.nz for full range of vessel basin options.*

Cabinet Options

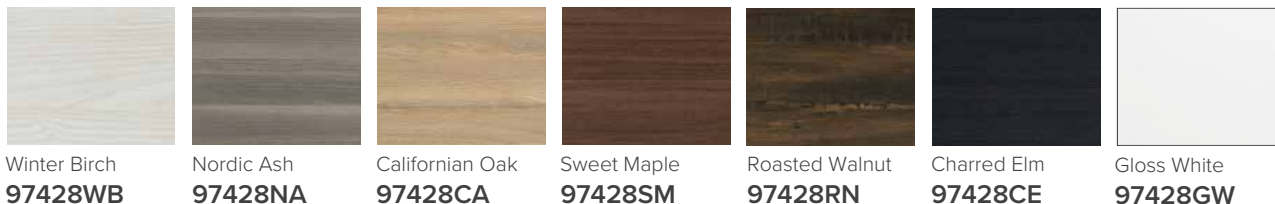

StoneCast Slab Top Options



Quartz Slab Top Options

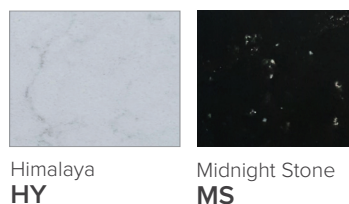

Note: To order a Slab Top, add the slab top code to the cabinet code.

Technical Details

Note: All measurements shown are in millimetres. Sizes are nominal.

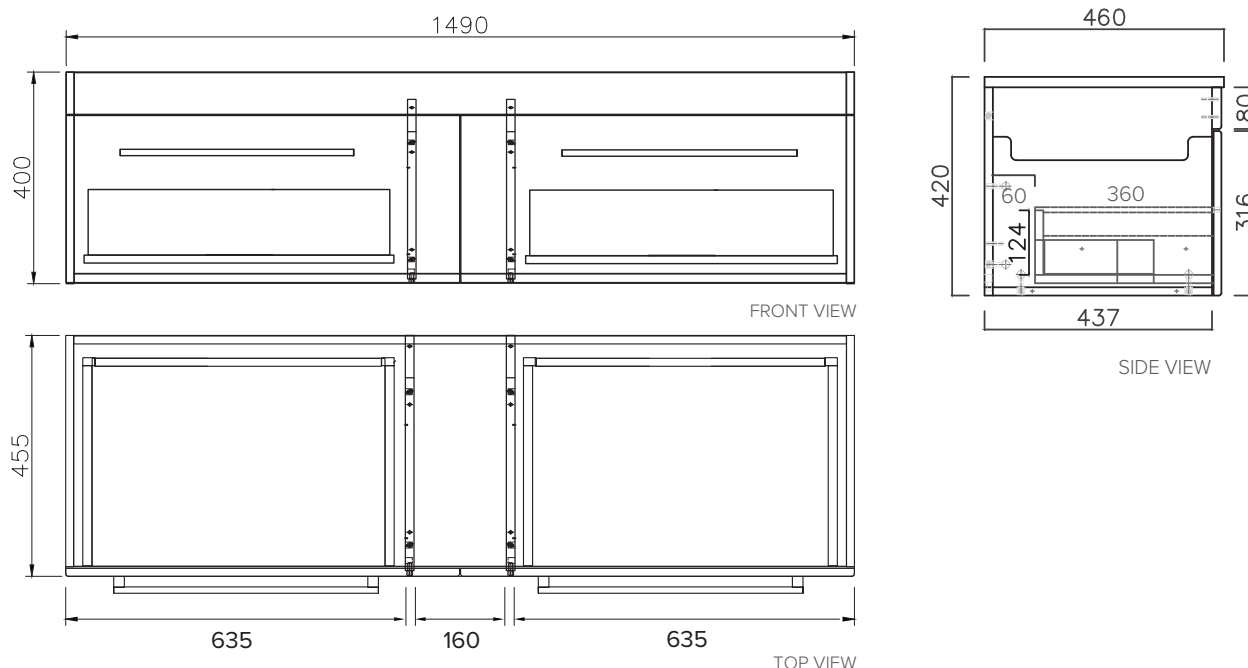

SPECIFICATION SHEET

Slab Top Options

StoneCast Slab Top 1500

W1500 x D465 x H20

Gloss White - SC

Matte White - SCMW

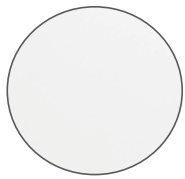
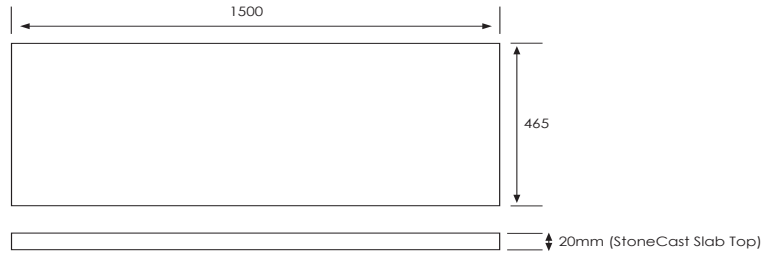
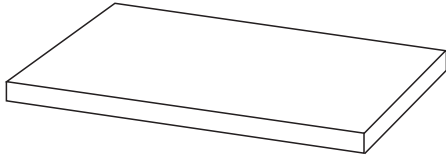

Gloss White



Matte White

Quartz Slab Top 1500

W1500 x D465 x H20

Midnight Stone - MS

Himalaya - HY

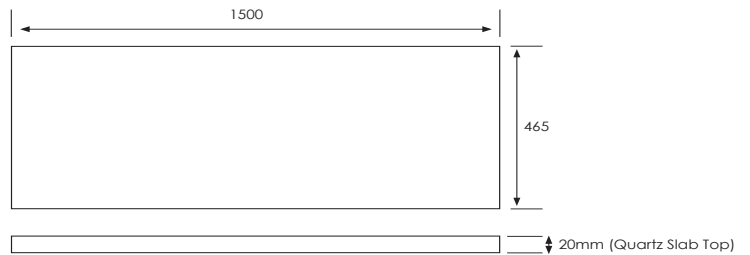
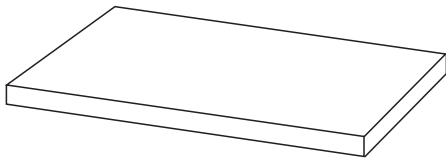

Midnight Stone

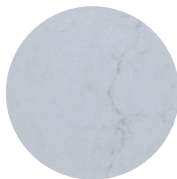

Himalaya

Tap Hole Position

Tap hole position must be specified

- NTH** No Tap Holes
- CTH** Centre Tap Holes
- LTH** Left Tap Holes
- RTH** Right Tap Holes
- ITH*** Inside Tap Holes
- OTH*** Outside Tap Holes

*only applicable with double basins