



Square

Vertical toilet paper holder
K-23289

Features

- Vertical holder makes changing toilet paper quick and simple.
- Coordinates with other products in the Square collection.

Material

- Premium metal construction for durability and reliability.
- KOHLER finishes resist corrosion and tarnishing.

Installation

- Installation hardware included.

Recommended Products/Accessories

K-23729 Stainless steel cleaner

Codes/Standards





None Applicable

KOHLER® Faucet Lifetime Limited Warranty

See website for detailed warranty information.

Available Colors/Finishes

Color tiles intended for reference only.

Color	Code	Description
	CP	Polished Chrome
	BN	Vibrant® Brushed Nickel
	BL	Matte Black
	2MB	Vibrant® Brushed Moderne Brass

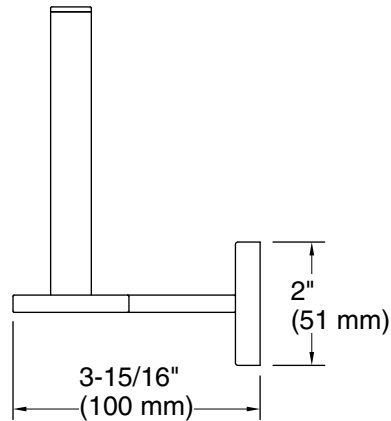
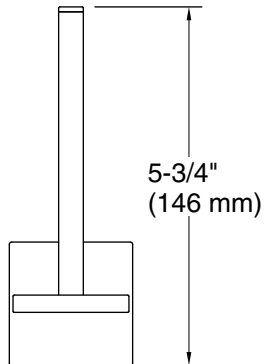
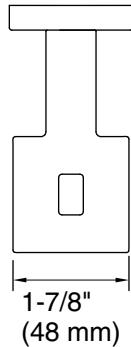

Technical Information

All product dimensions are nominal.

Material: Zinc, Stainless Steel

Notes

Install this product according to the installation instructions.

CAUTION: Risk of personal injury. Do not install these products in any area where they are likely to be used inadvertently as a grab bar or support bar. These products are not designed or intended for use as a grab bar or support bar.