

SPECIFICATION SHEET

Francisco 750 2-Drawer Wall Hung Vanity



Features

- 2-Drawer Wall Hung Vanity - *Colour options below*
- StoneCast 20mm Via Basin [Standard]
- *Upgrade options available*
- Full Extension Soft Close Drawers with Handles
- *Handle upgrade options available*
- Designer Drawer Fronts - *Four Drawer Front options*
- Dimensions: H670 x W750 x D465

Cabinet Options

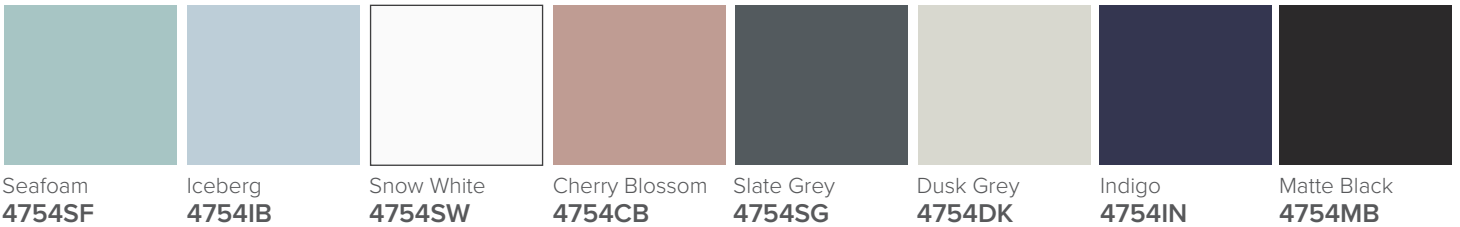

Technical Details

Note: All measurements shown are in millimetres. Sizes are nominal.

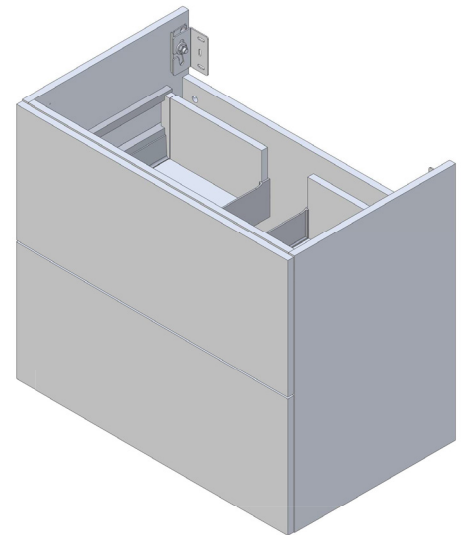
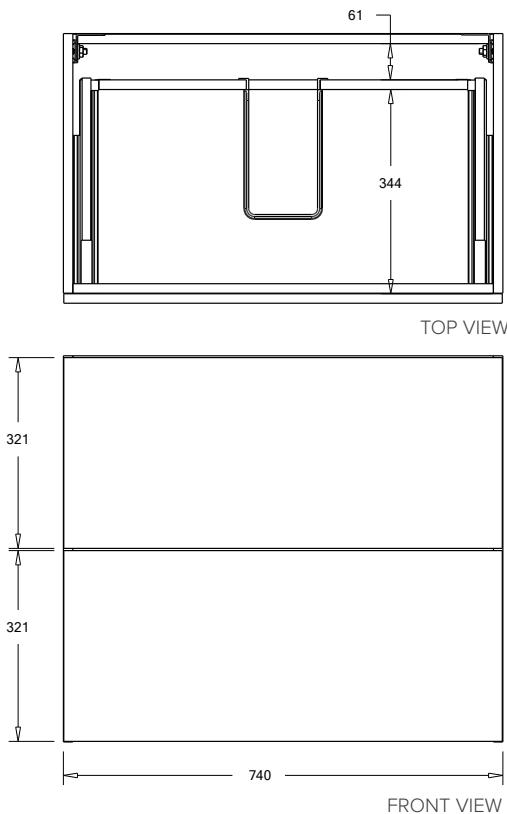

SPECIFICATION SHEET

Francisco Designer Drawer Fronts

BARNESLEY
18mm Inset Frame
Code: BL

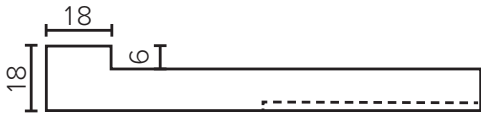
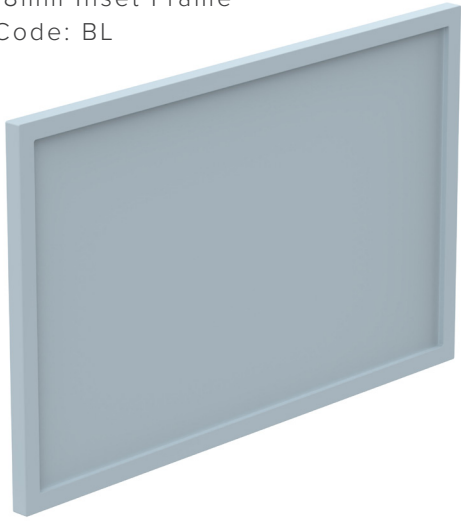

PRESTON
60mm Inset Frame
Code: PT

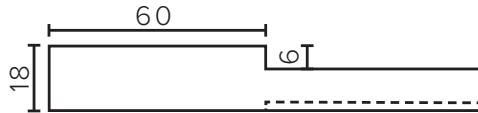
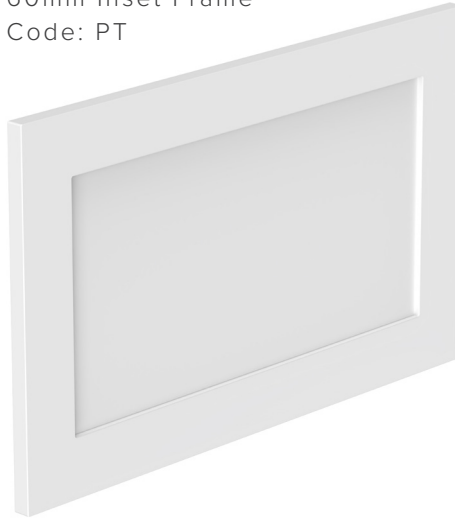

TURNBERRY
Ripple Design Panel
Code: TB

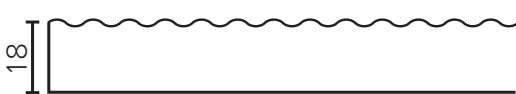
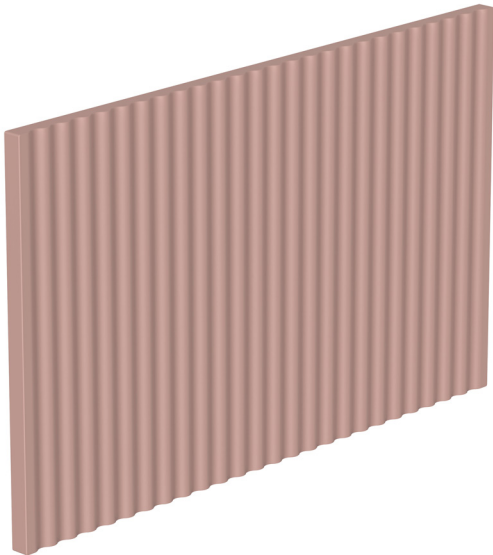

NEWPORT
V-Groove Panels
Code: NP

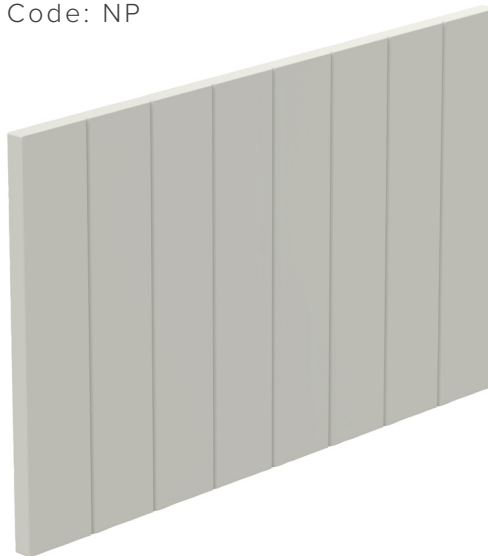

Seafoam

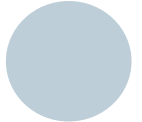

Iceberg

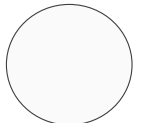

Snow White



Cherry Blossom



Slate Grey



Dusk Grey



Indigo



Matte Black