

# English Classic

vcbc

## DESCRIPTION

English Classic 700 Wall-Hung Vanity – 2 Drawer, Matt White

## PRODUCT CODE

ENG70D2WH



## FEATURES

- Dimensions: W710 x H632 x D485 mm
- Available in widths 600, 700, 800 and 1000mm (single bowl) – wall-hung or floor standing. Also available as a wall-hung cupboard.
- Ceramic top with overflow from Europe.
- Available in Satin White – The paint used on our products is polyurethane or UV based. It is five times harder and more durable than lacquer finishes.
- Soft-close drawers. New drawer heights offer storage variations.
- Chrome handles.
- Cabinet features Edwardian details.
- Cabinetry made in New Zealand.
- Pair with the Burlington range of tapware and accessories.\*

## PAINT FINISH\*



Matt White

## NOTES

\*Non-stock item. Excludes tap ware & accessories. See reverse page for technical drawings.

**MICHEL CÉSAR**  
**VCBC**  
**BURLINGTON**  
**LAUNDRY**

/ WHERE BATHROOMS  
& LAUNDRIES  
COME TOGETHER  
BEAUTIFULLY /

info@smail.co.nz  
bathco.co.nz

4-8 Ace Place  
Kingsland  
Auckland 1021  
New Zealand

P +64 9 309 9109  
F +64 9 309 9343

86 Wigram Road  
P.O. Box 8644  
Christchurch 8025  
New Zealand

P +64 3 343 0969  
F +64 3 343 0967

**BATH/**  
**CO/**

# English Classic

vcbc

## DESCRIPTION

English Classic 700 Wall-Hung Vanity – 2 Drawer, Matt White

## PRODUCT CODE

ENG70D2WH

## TECHNICAL DRAWINGS

Top

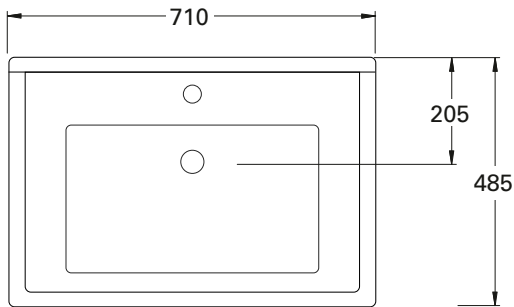

Back of Basin

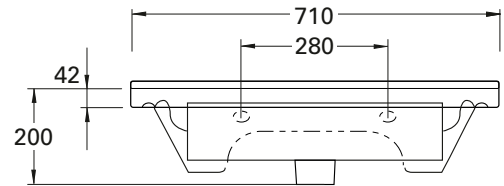

Front

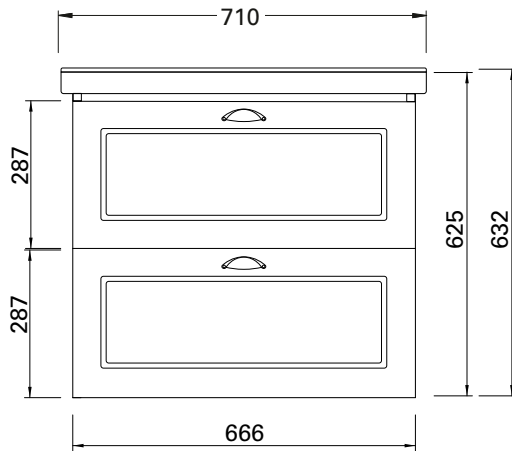

Side

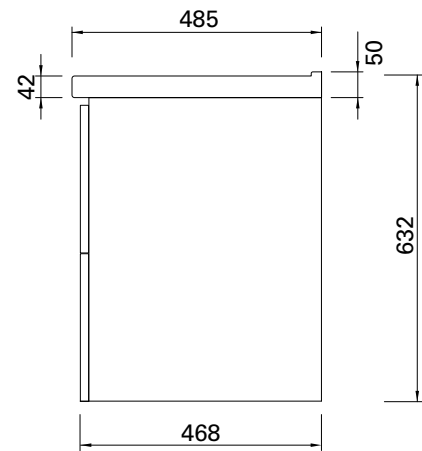

## NOTES

Drawing indicates the technical measurement only and is not a reflection of how the unit will look. Sizes are nominal only. All drawings in millimeters. Drawings not to scale.