

INSTALLATION INSTRUCTIONS



Trusted in New Zealand Since 1982

DURACYL WALL



- Flat Shower Wall
- Flat Bath Wall

- Side Contour Wall
- Corner Contour Wall

- Corner Contour PLUS Wall

CORNER CONTOUR PLUS

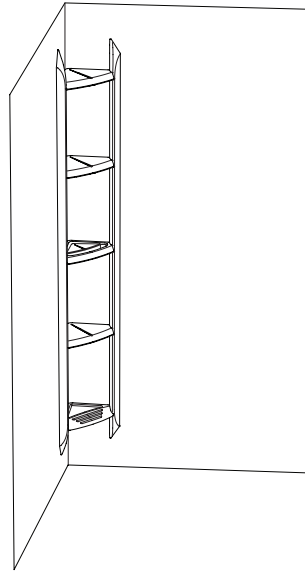

CORNER CONTOUR

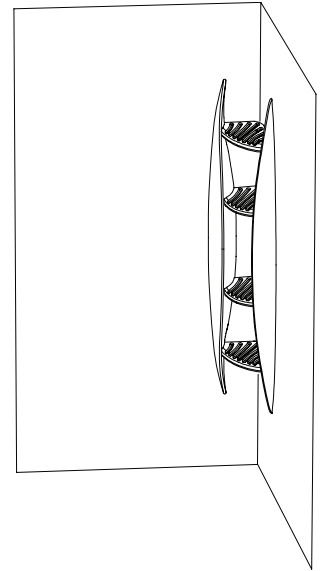

BATH WALL

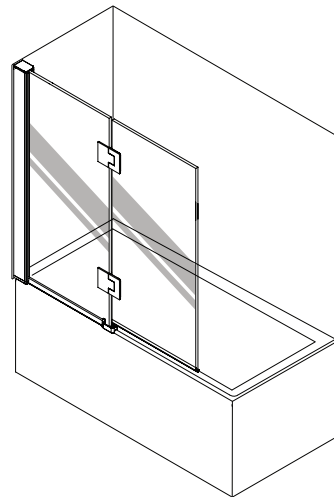

FLAT WALL

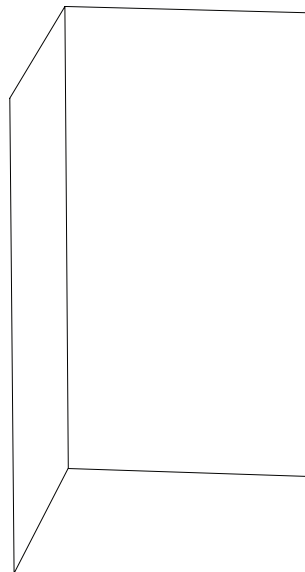

SIDE CONTOUR

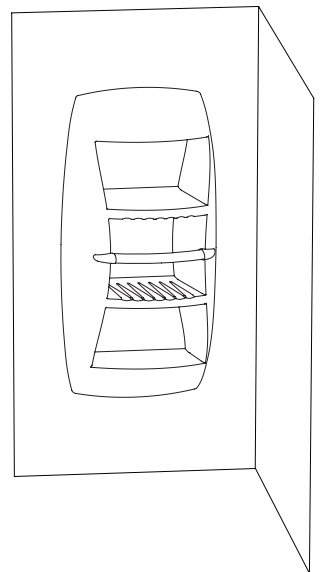

Englefield has a history of making superb showers and their popularity is testament to their quality and affordability.

It's the details that Englefield cares about - from pioneering the latest technology, to innovative design, it's all to make your showering experience the very best it can be.

Note: Bath and bath screen not included.

BEFORE YOU BEGIN



IMPORTANT

Read all instructions carefully before starting the installation to ensure the best possible results. It is the responsibility of the installer to ensure that the installation complies with council and local authority bylaws.

Before installing the liner, ensure the moulded feature is not obstructed. For Corner Contour walls there should be no plumbing fittings within 300mm of the corner(s).

Instructions, drawings, and diagrams contained in this manual present information available at the time of printing. Although every attempt has been made to keep them up-to-date, Kohler Company reserves the right to implement product changes without further notice.

TOOLS AND MATERIALS REQUIRED

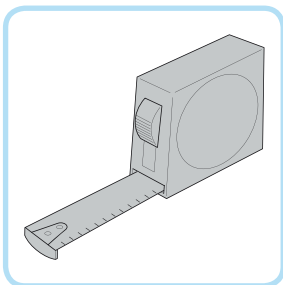

Tape measure



Soft pencil

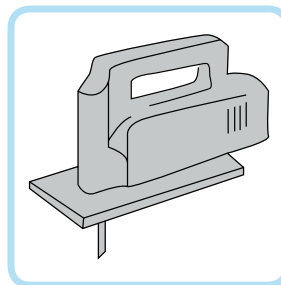

Jigsaw (fine blade)

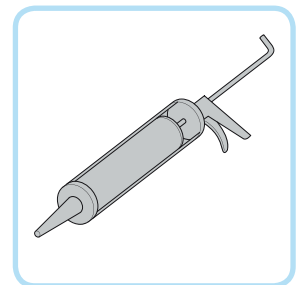

Caulking gun

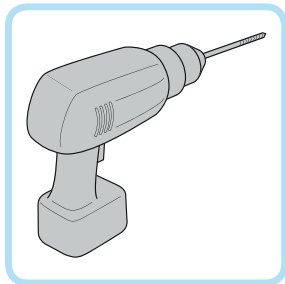

Drill

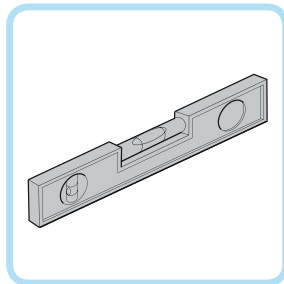

Spirit level

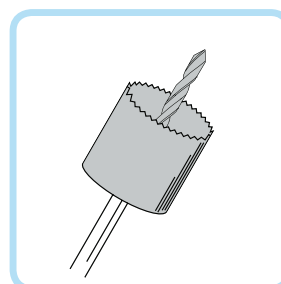

Hole saw

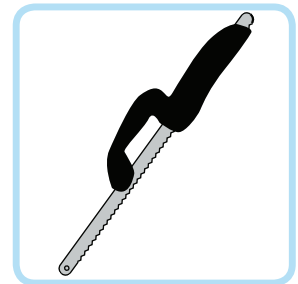

Fine toothed saw

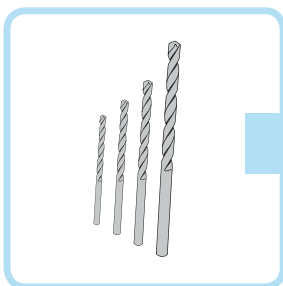

Drill bits

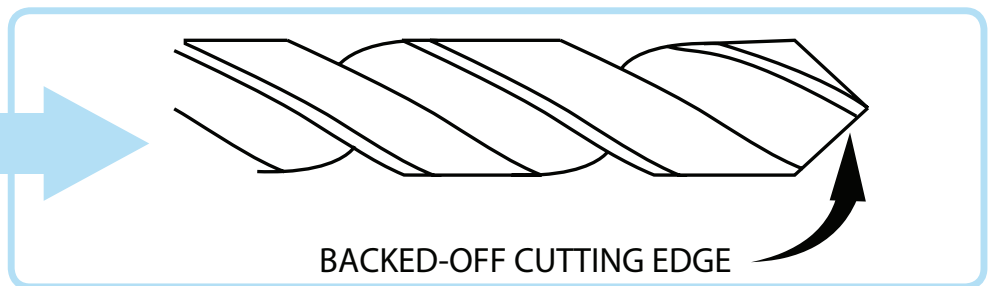

BACKED-OFF CUTTING EDGE



IMPORTANT

Use only recommended sealants and adhesives, suitable on acrylic and acrylic capped ABS; unsuitable products may damage the Duracryl wall.

DRILLING AND CUTTING DURACRYL

Small holes can be drilled with a twist drill, but the cutting edge **MUST** be backed off with an oil stone (the sharp edge dulled). Large holes must be drilled with a hole saw.

Maximum drill size : 12 mm. Drill speeds: 6 mm x 1800 RPM ; 12 mm x 900 RPM.

If for any reason the Duracryl requires cutting, use a fine tooth hacksaw and proceed with caution. Edges can be smoothed with a second-cut file and medium-fine sandpaper. If the surface of the Duracryl happens to be damaged, it can be restored by polishing with an appropriate compound.

SEALANT & ADHESIVE

The recommended adhesive and sealants are:

- Sika Shower Bond to adhere the acrylic liner to the wallboard.

Usage: • 3 cartridges for 2 sided wall liners
 • 4 cartridges for 3 sided wall liners

- Sika Sikasil NG (White) to seal the acrylic liner to shower tray or bath.

These are available in separate Adhesive & Sealants Packs. Each Pack contains enough adhesive and sealant for a complete shower enclosure or shower over bath installation. For stockists phone 0800 100 382 (NZ) or 1800 ENGLEFIELD (Australia).

16520A-0

Adhesive & sealant pack - **2 sided** wall liner for **white** framed showers.

16521A-SHP

Adhesive & sealant pack - **2 sided** wall liner for **metallic/black** framed showers.

16522A-0

Adhesive & sealant pack - **3 sided** wall liner for **white** framed showers.

16523A-SHP

Adhesive & sealant pack - **3 sided** wall liner for **metallic/black** framed showers.



CONSTRUCTION REQUIREMENTS - TIMBER FRAME

1) For showers, identify the type of installation required and construct timber frame in accordance with **figures 1 or 2** below. Englefield recommends installing double studs to fix the wall retainers to. A typical shower enclosure timber frame is shown in **figure 3**. For the framing of bath tubs and screens, please refer to the installation guide supplied with the product.

2) Fix wall board to the studs.

The wall board surface must be flat and plumb.
The corner must be square.

IMPORTANT Do not plaster, paint or seal the wall board.

Fig.1: Alcove (3 sided) Wall

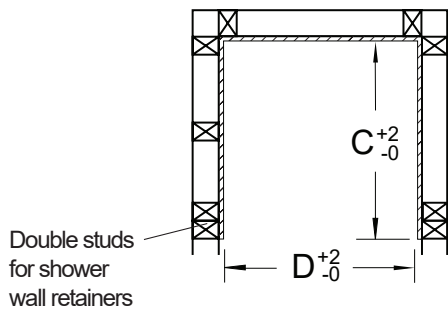

WALL BOARD	C	D
900 X 750 X 900	885	747
750 X 900 X 750	739	864
900 X 900 X 900	884	864
1000 X 1000 X 1000	984	964
900 X 1200 X 900	884	1164

*Note: Dimensions are to the finished surface of wall board.

Fig.2: Corner (2 sided) Wall

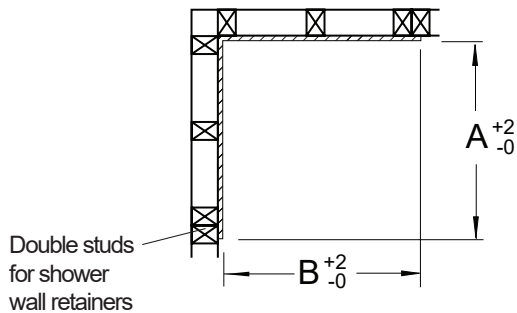

WALL BOARD	A	B
900 X 750	739	879
900 X 900	884	884
1000 X 1000	984	984
1200 X 900	884	1184

Fig. 3: Recommend Timber Frame for Shower Enclosure Installation

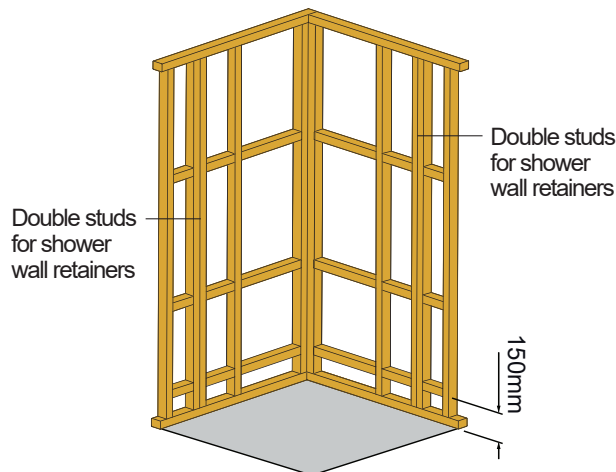

DURACRYL WALL INSTALLATION

1. PREPARING WALL AND SPACE

Ensure the shower tray or bath tub is installed correctly, as detailed in the installation guide supplied with the product. Peel back protective film of the tiling bead of shower tray or bath in order to make a water tight seal possible.

Ensure the surface of tray or bath tub is protected during installation, and no debris can get into the waste hole. For bath tubs use a drop cloth.

For shower trays, select appropriate size, then cut base protector from back of shower tray carton. Place it in shower tray as per **figure 4**.

Fig.4: Cutting base protector

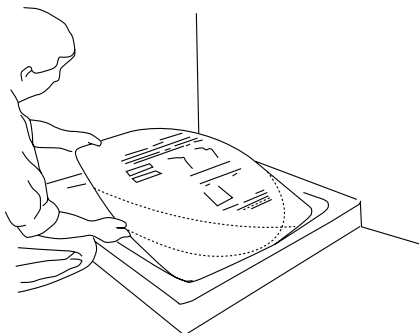

Mark and drill holes required for outlet fittings as per **figure 5**.

NOTE: Follow the drilling and cutting instructions from page 3.

Fig.5: Mark and drill holes for plumbing

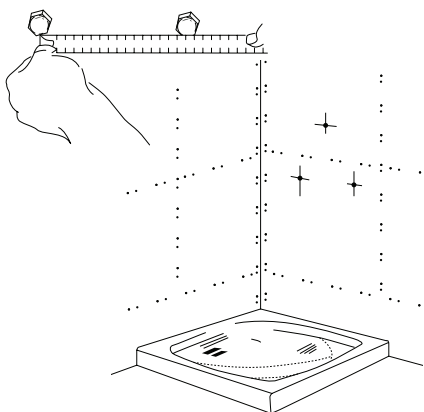

Position wall in place. Check fit to ensure wall fits squarely into corner as per **figure 6**. Tape edges to hold into position.

Fig.6: Positioning wall

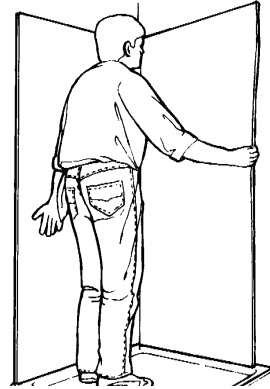

Where necessary (bath) notch the edge of wall to fit over the tiling bead as shown in **figure 7**.

Fig.7: Bath tub notching

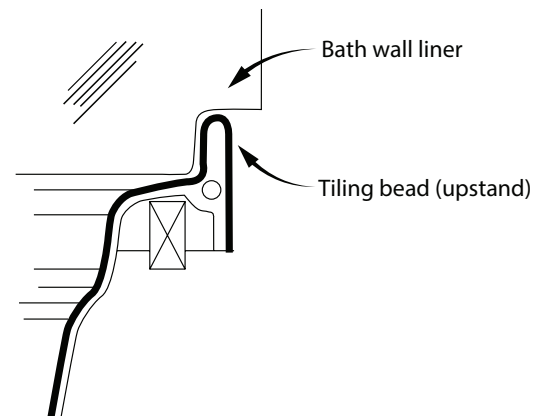

Before marking, make sure the wall is pressed firmly into the corner of wall.

With a soft pencil, mark around the perimeter of the wall liner. This will be the basis for marking the glue pattern as per **figure 8**.

Fig.8: Marking liner edge onto wall board

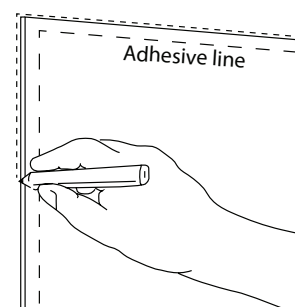

DURACRYL WALL INSTALLATION CONT...

MARKING ADHESIVE PATTERN

Carefully **measure and mark pattern** on wall board surface as shown in **figure 9**.

This pattern applies to:

- Flat shower wall
- Side contour shower wall
- Flat bath wall



IMPORTANT Mark the pattern but do not apply adhesive at this stage.

NOTE: Measurements from edges, top and base. All dimensions below are in millimeters.

Fig.9: Adhesive pattern for Flat & Side Contour

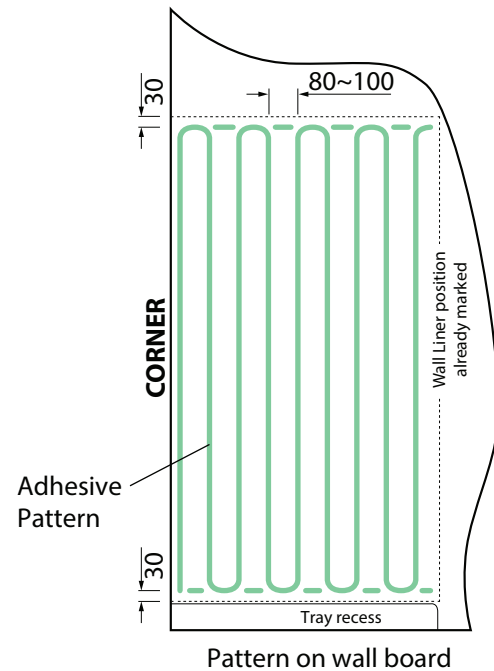

For corner contour shower walls, the pattern must be marked on both wall board **and** Duracryl liner. Refer to figures below for both patterns: • Corner Contour PLUS Wall - **figure 10**
• Corner Contour Wall - **figure 11**

At this stage it is essential that the back side of the Duracryl wall and the surface of the wall board are wiped clean with a damp cloth. This will ensure that all dust is removed from both surfaces and provide a clean surface for the adhesive. Allow both surfaces to dry before adhesive application.

Fig.10: Adhesive pattern for Corner Contour PLUS Walls

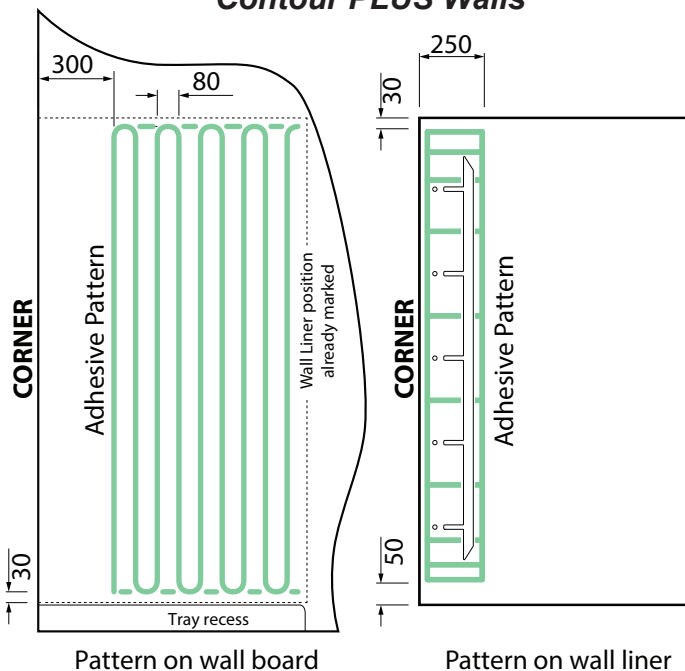
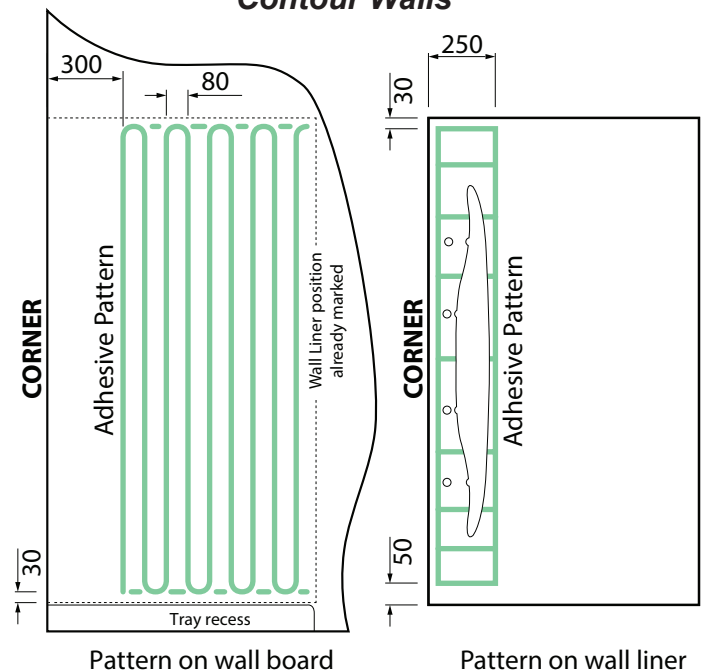

Fig.11: Adhesive pattern for Corner Contour Walls



DURACRYL WALL INSTALLATION CONT...

APPLYING THE ADHESIVE

Prepare sealant and adhesive cartridges.

Cut nozzle on sealant and adhesive cartridges as shown in **figure 12** below.

Pierce protective foil inside adhesive cartridge.

Fig.12: Cutting cartridges

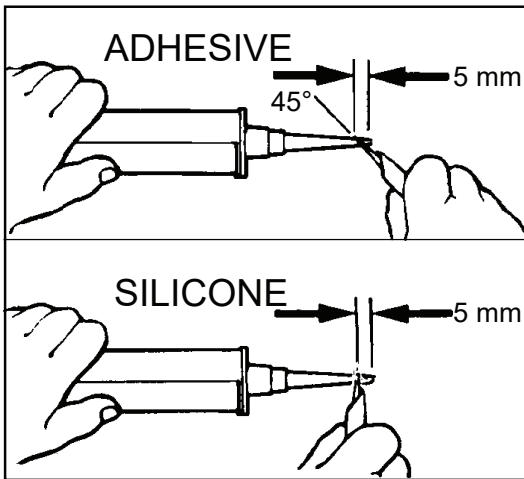

Apply sealant to shower tray or bath first as shown in **figure 13** below.

Apply a bead of sealant for **50 mm** from both front corners at base of upstand as shown.

Apply a second full length bead at top of upstand.

Fig.13: Apply beading to upstand

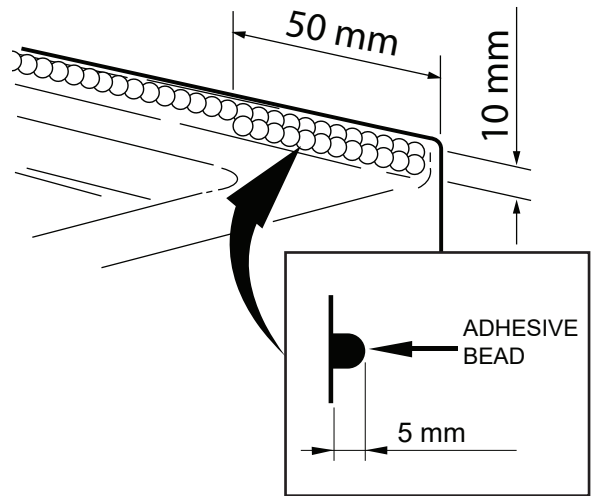

Apply adhesive to wall board.

Do not use on previously painted, sealed, ceramic or plastered walls.

Use only on the following substrates:

- Villaboard
- Fibre cement
- Plaster Board

Follow the pattern marked. Start at top working your way down. Apply vertical pattern first then fill in horizontal lines.

For shower walls with corner features remember to apply the adhesive on the acrylic wall as shown on previous page (**figures 10 & 11**).

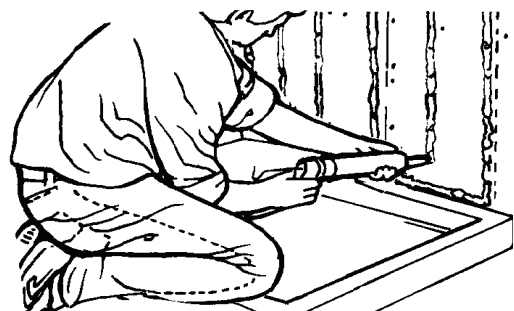

CAUTION

Do not apply adhesive below 5°C. Temperatures below this point will require the adhesive to be warmed up to assist with adhesive flow and application.

Use only in ventilated areas.

IMPORTANT

Ensure the protective film has been peeled back from tiling bead of tray or bath before applying sealant. Leave the rest of the tray or bath covered by the film to protect it during installation.

DURACRYL WALL INSTALLATION CONT...

To install the wall follow the approved adhesive manufacturer instructions.

As a general rule, place wall into position. Press firmly back into corner to ensure that wall makes full contact with the corner along its entire length.

Press into corners first, then press toward edges. Use a soft clean cloth to press firmly and remove any rippling along glue lines. Check and repress if necessary.

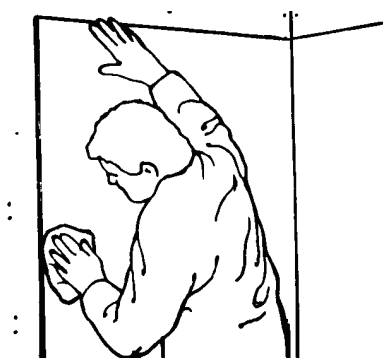

Allow the adhesive to cure before installing the shower or bath and/or using the enclosure.

Remove the plastic film from liner before use.

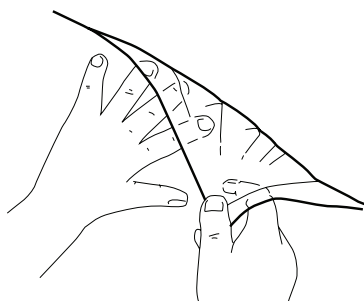

CLEANING INSTRUCTIONS

Use non-abrasive soap and warm water.

Avoid:

- harsh chemicals and disinfectants.
- abrasive cleaners
- solvent based cleaners
- acid or alkaline cleaners
- products containing ammonia or peroxides.

Wipe out the unit after each use to prevent build-up of soap and scum.

Always read the label instructions on any cleaner carefully before applying it to the surface.



Read the Care & Maintenance label on the wall and leave it in place for the end user.

CONTACT & WARRANTY INFORMATION

KOHLER NZ LTD NEW ZEALAND

Free Fax: 0800 664 488

Free Ph: 0800 100 382

www.inglefield.co.nz

KOHLER CO. AUSTRALIA

Free Ph: 1 800 ENGLEFIELD

(1 800 364 533)

www.inglefield.com



Trusted in New Zealand Since 1982

For warranty information, please visit our website.