

## UNO SQUARE KITCHEN MIXER - BRUSHED NICKEL

43935.04

ELEMENTi

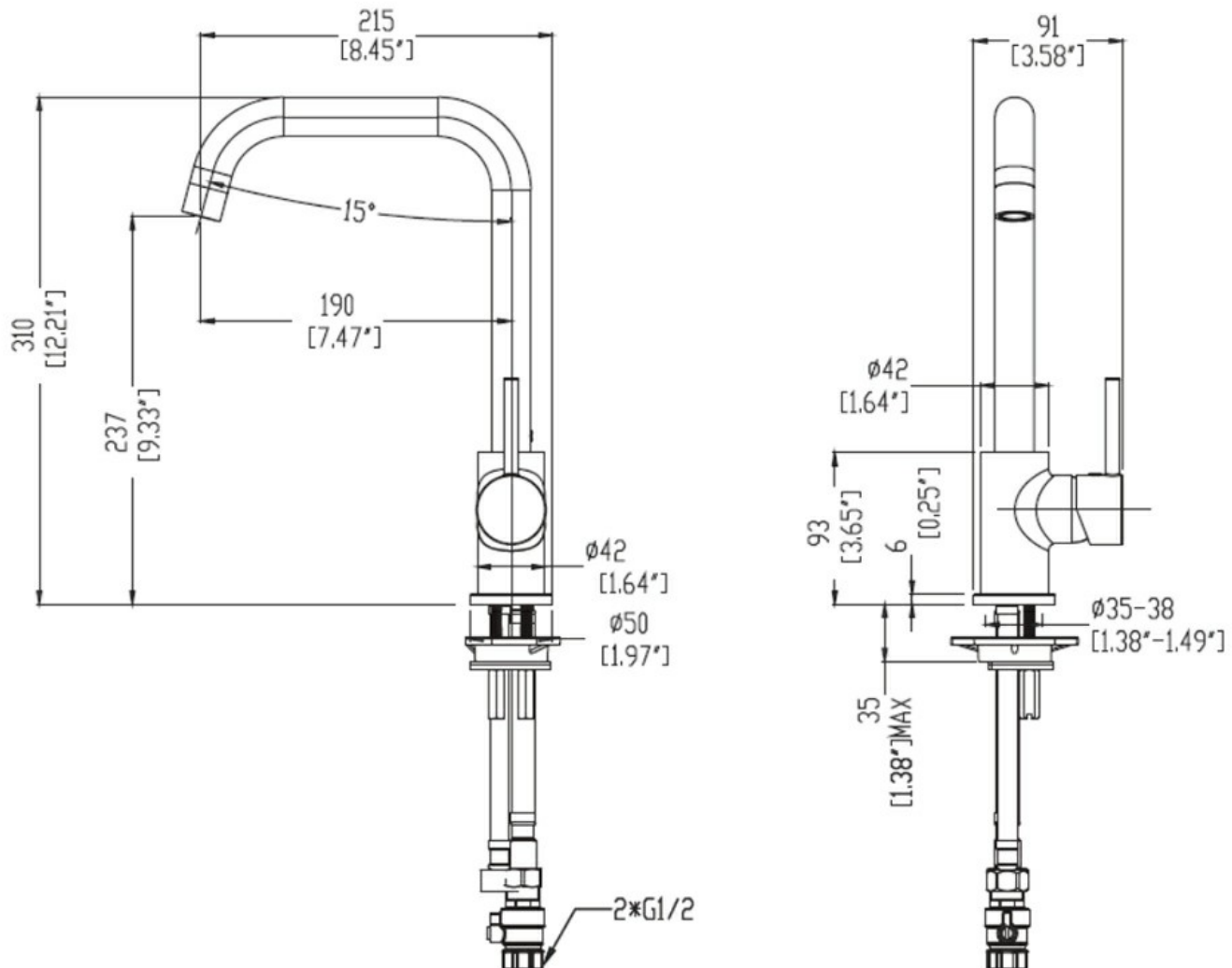

Residential/Light Commercial Use

Suitable for Residential/Light Commercial Use (Kitchens, Bathrooms and Laundries in Hotels, Motels and Retirement Villages).

5

Guarantee

5 Year Guarantee on coloured finish

10

Guarantee

10 Year Guarantee



4 Star WELS rating

7 litres per minute. Low/Unequal pressure.



5 Star WELS rating









5.5 litres per minute. Mains Pressure



Mains Pressure

Suitable for Mains Pressure.



	Multi Pressure	Suitable for Multi Pressure.
	Flawless Finish	Advanced plating provides a durable surface with a long lasting finish
	Effortless Control	Advanced cartridge technology provides a wide operating angle and smooth operation
	Swivel Spout	The Swivel spout provides space, flexibility and ease of use.
	Chrome Plate	A base of copper is first applied followed by a layer of nickel and then finally a hard gloss coating of chromium to achieve a shiny hard wearing finish.
	Blackened Oil Bronze: Black	Parts are firstly nickel plated then blackened oxidation process to apply the base colour. and a transparent liquid polymer is applied achieve a mat finish and hardened surface.
	Electroplated: Gun Metal	Electrical current is used to dissolve components into Lacquer that then adhere to the surface.
	Electroplated with PVD: Brushed Nickel	Electrical current is used to dissolve components into Lacquer that then adhere to the surface. A thin metal-spray coating in the form of very thin layers is finally applied using PVD process.
	Electroplated with PVD: Brushed Brass	Electrical current is used to dissolve components into Lacquer that then adhere to the surface. A thin metal-spray coating in the form of very thin layers is finally applied using PVD process.

The Uno Square kitchen mixer is designed for efficiency in the kitchen environment with an ergonomic spout height of 237mm and 15 degree operating angle allowing ease of use for tasks like filling of washing large pans, while the clever handle temperature control rotates from upright to forward where the mixer is places against a wall with limited space, ensuring the handle does not hit the splash back.