

CODE	FINISH
325X325	STAINLESS STEEL

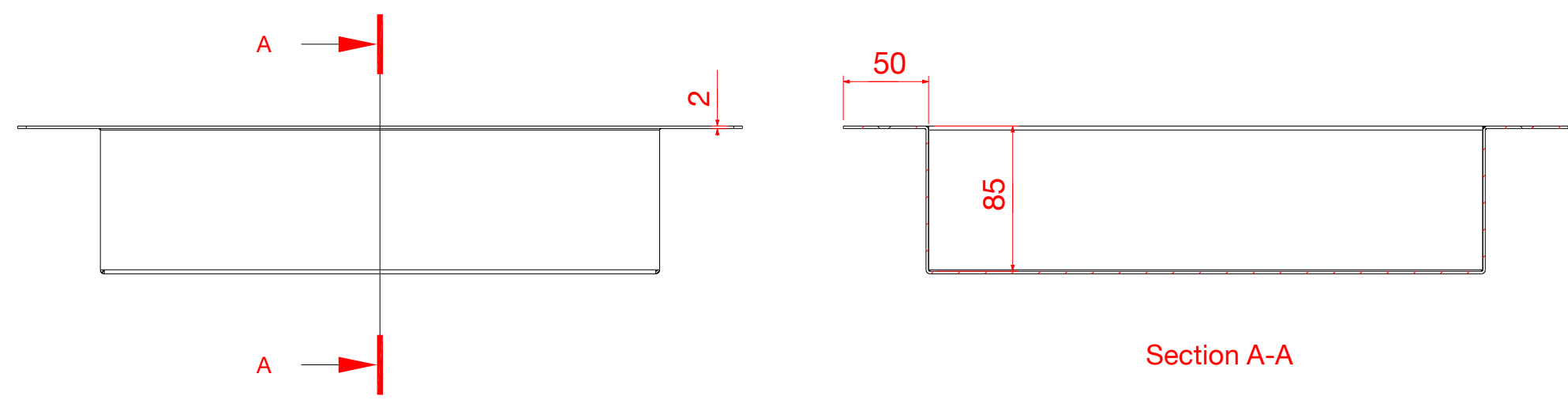
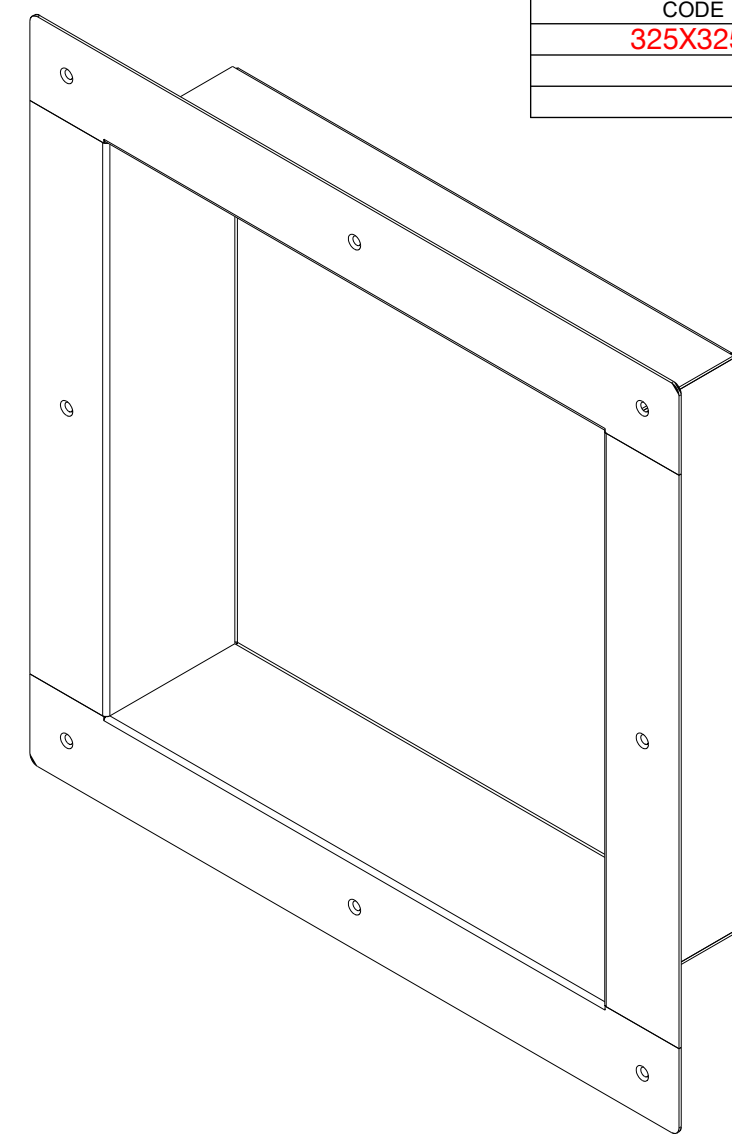
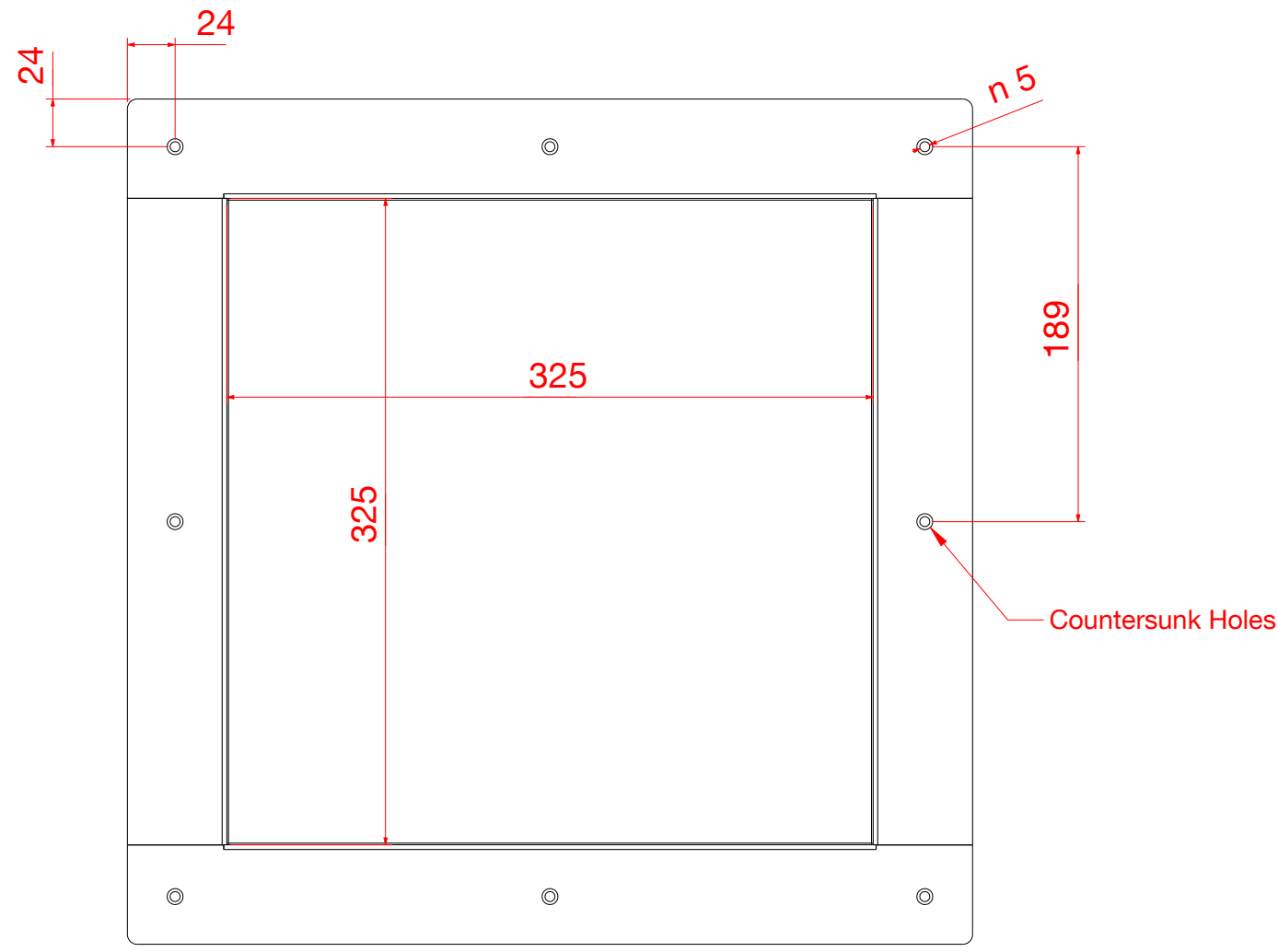

Section A-A

REVISION	CHANGE	DESCRIPTION	DRAWN	DATE
DO NOT SCALE DRAWING		TITLE		
REQUESTED	DATE	325x325x85 Shower Niche		
DRAWN	DATE			
MATERIAL		DRAWING REF NUMBER		
A3	UNITS = MM	SCALE (UOS)	SHEET 1 OF 1	

This product drawing is provided for informational purposes only. The drawing is based upon information supplied to Allproof and may not contain the full details required for the contract. We strongly recommend that you obtain appropriate expert advice from engineers, architects and other expert personnel to ensure the accuracy and completeness of the drawing and compliance with local authorities and legislation. Allproof Industries NZ Limited accepts no liability whatsoever for any loss or damage of any kind arising from provision of this drawing to you, including consequential loss whether suffered or incurred by you or another person or entity and whether in contract, tort or otherwise. You indemnify Allproof Industries NZ Limited against any liability that we incur in respect of loss or damage of any kind, including damage to property, death or personal injury, suffered or incurred by any person or entity and whether in contract, tort or otherwise, which arises from provision of this drawing to you, and any reasonable costs, claims, demands and expenses arising out of or in connection with that liability.