

Float

vcbc

DESCRIPTION

Float 1700mm Freestanding Bath

PRODUCT CODE

15.B.32489



FEATURES

- Dimensions - L1700 x H600 x W800 mm
- Double-ended, rectangular design with thin edge.
- Made from an acrylic that has a sensual surface with excellent thermal properties. It is able to retain heat and warm to touch.
- Weight: 61kg
- Water capacity: 395L / Displaced capacity: 325L (bath's capacity less 70 litres to allow for average person in bath)
- Note: no overflow
- No pre-drilled tap holes

TECHNICAL DRAWINGS

Top

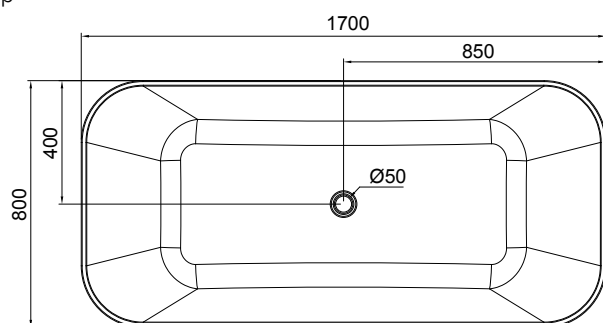

Side Section

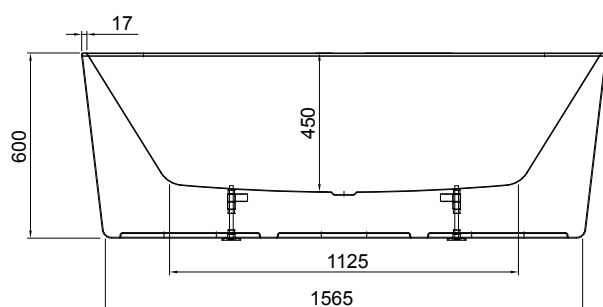

End Section

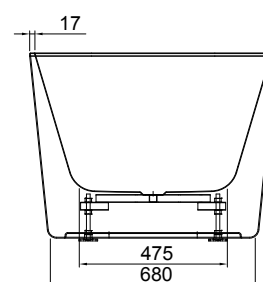

NOTES

Tapware and accessories not included. Drawing indicates the technical measurement only and is not a reflection of how the unit will look. Sizes are nominal only. All drawings in millimeters. Drawings not to scale. September 2019.